

Kvikguide

Kabelføringsystem

Kabelstiger, kabelbakker, gitterbakker og armaturskinner

Korrosionsklasser

Korrosionsklasser

Kabelbæresystemers levetid afhænger af de miljøer, de placeres i.

Det er derfor vigtigt at fastslå korrosionsegenskaberne for et miljø, så man kan være sikker på, at man vælger det rigtige materiale med den rigtige overfladebehandling. Til det formål er der opstillet forskellige korrosionsklasser i overensstemmelse med BSK99. De forskellige korrosionsklasser fremgår af nedenstående tabel. I tabellens sidste kolonne viser vores forslag til materialevalg og/eller overfladebehandling.

Arbejdsmiljøer for stålkomponenter kan hvad angår deres korrosionsegenskaber opdeles i korrosionsklasser (C1 - C5-M). Jævnfør tabel 1.

- Referenceværdier for ståls og zinks gennemsnitlige korrosion er anført i tabel 2
- Korrosionsklasserne følger inddelingen, der anvendes i NEN-EN-ISO12944-2

Tabel 1

Korrosionsklasser er givet iht. SS-EN ISO 12944-2 med atmosfæriske korrosionsniveauer og eksempler på det miljø, hvortil de er mest egnede.

Korrosionsklasse	Miljø korrosion	Eksempler på typiske miljøer i tempereret klima.		Anbefalet minimum overfladebehandling
		Udendørs	Indendørs	
C1	Meget lav	-	Opvarmede rum med tør luft og ubetydelig luftforurening, f.eks. kontorer, forretninger, skoler og hoteller.	El-galvaniseret FZB, EZ
C2	Lav	Områder med lav luftforurening. Landlige områder.	Ikke opvarmede rum med vekslende temperaturer og fugtighed. Lav frekvens af luftkondensering og lav luftforurening, f.eks. sportshaller og lagerlokaler.	Sendzimirgalvaniseret FSZ Z 275 iht. SS-EN 10142
C3	Middel	Områder med lavt indhold af salt eller moderat mængde luftforurening. Byområder og lette industriområder. Områder med moderat indflydelse fra hav og kyst.	Rum med høj fugtighed og en stor mængde luftforurening fra produktion, f.eks. bryggerier, mejerier og vaskerier.	Varmgalvaniseret FZV og Zinc+ efter produktion iht. SS-EN ISO 1461
C4	Høj	Områder med lavt indhold af salt eller moderat mængde luftforurening.	Rum med høj fugtighed og en stor mængde luftforurening fra produktion, f.eks. kemisk industri, industri- og kystområder.	Varmgalvaniseret FZV efter produktion iht. SS-EN ISO 1461
C5-I	Meget høj (industriel)	Industrielle områder med høj luftfugtighed og aggressiv industri- og kystområder.	Rum med næsten permanent fugtkondensation og en stor mængde luftforurening.	Zinkpox® Varmgalvaniseret + epoxy-lak.=Zinkpox Rustfri stål SS2348 AISI 316
C5-M	Meget høj (marine)	Kyst- og offshore områder med store mængder salt.	Rum med næsten permanent fugtkondensation og en stor mængde luftforurening.	Rustfri stål SS2348 AISI 316

Tabel 2

Massetab for stål og zink i forskellige korrosionsklasser.

Korrosionsklasse	Massetab pr. overfladeenhed og reduktion i tykkelse (1 års holdbarhed) ¹⁾			
	Stål Massetab (g/m ²)	Tykkelse reduktion (µm)	Zink Massetab (g/m ²)	Tykkelse reduktion (µm)
C1	10	1,3	0,7	0,1
C2	>10 til 200	>1,3 til 25	>0,7 til 5	>0,1 til 0,7
C3	>200 til 400	>25 til 50	>5 til 15	>0,7 til 2,1
C4	>400 til 650	>50 til 80	>15 til 30	>2,1 til 4,2
C5-I	>650 til 1500	>80 til 200	>30 til 60	>4,2 til 8,4
C5-M	>650 til 1500	>80 til 200	>30 til 60	>4,2 til 8,4

¹⁾ Korrosionshastigheden er generelt højere, når materialet først er blevet udsat.

Belastningsskemaer

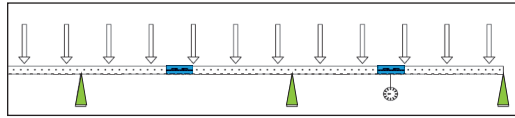

Godkent iht. IEC 61537.

Maks. belastning i kg. pr. meter/nedbøjning i mm, ved afstand mellem konsollerne på:

Kabelstiger	1 meter	1,5 meter	2 meter	3 meter	4 meter
KHZSP Bredde 200 - 600 mm		250 / 7,5	140 / 11	55 / 17	25 / 20
KHZPS Bredde 150 - 600 mm		350 / 11	190 / 12	80 / 25	35 / 37
KHZP/KHZ Bredde 150 - 600 mm		440 / 7,5	245 / 16	100 / 25	50 / 47

Kabelbakker	1 meter	1,5 meter	2 meter	3 meter	4 meter
KB184 Bredde 100 mm		110 / 10	70 / 15	25 / 27	
KB184 Bredde 300 mm		48 / 5	78 / 7	22 / 30	
KB184 Bredde 600 mm		33 / 3	160 / 5	40 / 10	
KB284 Bredde 100 mm		150 / 10	40 / 20	20 / 30	
KB284 Bredde 300 mm		95 / 7	35 / 12	20 / 30	
KB284 Bredde 600 mm		110 / 9	50 / 7,5	30 / 18	

Langsgående nedbøjning 1% af afstanden					
Gitterbakker	1 meter	1,5 meter	2 meter	3 meter	4 meter
Bredde 100 mm	80	50	22		
Bredde 150 mm	90	50	40		
Bredde 200 mm	100	52	45		
Bredde 300 mm	110	65	50		
Bredde 400 mm	130	70	60		
Bredde 500 mm	125	70	65		
Bredde 600 mm	155	80	60		

Armaturskinner	1 meter	1,5 meter	2 meter	3 meter	4 meter
		50 / 3,5		50 / 30	

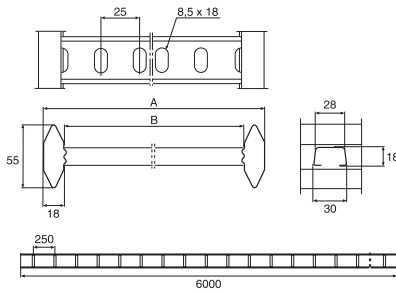







Kabelstige KHZSP til lette belastninger

Materiale: Sendzimirgalvaniseret stål, FZS
 Korrosionsklasse; C2
 Længde: 6 meter

Kabelstige KHZSP





P139619

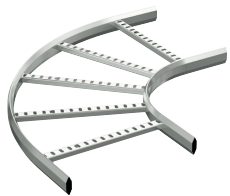

Beskrivelse	Dimensioner i mm A/B/C	 Vare-nr.	EAN-kode
Kabelstige KHZSP			
Kabelstige KHZSP 200	55/198/6000	734 488	 7 321677 344888
Kabelstige KHZSP 300	55/298/6000	734 489	 7 321677 344895
Kabelstige KHZSP 400	55/398/6000	734 490	 7 321677 344901
Kabelstige KHZSP 500	55/498/6000	734 491	 7 321677 344918
Kabelstige KHZSP 600	55/598/6000	734 492	 7 321677 344925

P140034



















Indvendig 90° bøjning 15			
Indvendig 90° bøjning 15/200	55/597/597	723 061	 7 321677 230617
Indvendig 90° bøjning 15/300	55/697/697	723 062	 7 321677 230624
Indvendig 90° bøjning 15/400	55/797/797	723 063	 7 321677 230631
Indvendig 90° bøjning 15/500	55/897/897	723 064	 7 321677 230648
Indvendig 90° bøjning 15/600	55/997/997	723 065	 7 321677 230655

P140035



Udvendig 90° bøjning 15, varmgalvaniseret			
Udvendig bøjning 90° 15/200	55/933/933	716 180	 7 321677 161805
Udvendig bøjning 90° 15/300	55/1133/1133	716 182	 7 321677 161829
Udvendig bøjning 90° 15/400	55/1333/1333	716 183	 7 321677 161836
Udvendig bøjning 90° 15/500	55/1533/1533	716 184	 7 321677 161843
Udvendig bøjning 90° 15/600	55/1733/1733	716 185	 7 321677 161850

Kabelstige KHZSP

	Beskrivelse	Dimensioner i mm	 Vare-nr.	EAN-kode
P140034	T-afgrening, varmgalvaniseret			
	T-afgrening 16/200	55/997/597	716 194	
	T-afgrening 16/300	55/1097/697	716 196	
	T-afgrening 16/400	55/1197/797	716 197	
	T-afgrening 16/500	55/1297/897	716 198	
	T-afgrening 16/600	55/1397/997	716 199	
P140039	X-afgrening, varmgalvaniseret			
	X-afgrening 17/200	55/997/997	716 210	
	X-afgrening 17/300	55/997/997	716 212	
	X-afgrening 17/400	55/997/997	716 213	
	X-afgrening 17/500	55/997/997	716 214	
	X-afgrening 17/600	55/997/997	716 215	
P140032	Vertikalafgrening, varmgalvaniseret			
	Vertikalafgrening 18/200	452/197/452	718 177	
	Vertikalafgrening 18/300	452/297/452	718 179	
	Vertikalafgrening 18/400	452/397/452	718 180	
	Vertikalafgrening 18/500	452/497/452	718 181	
	Vertikalafgrening 18/600	452/597/452	718 182	

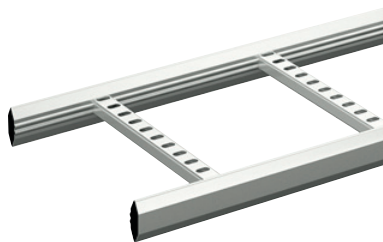
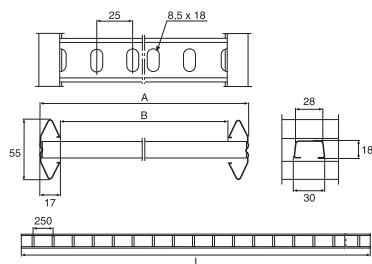







Kabelstige KHZPS til store belastninger

Materiale: Sendzimirgalvaniseret stål, FZS
Korrosionsklasse; C2
Længde: 6 meter

Kabelstige KHZPS







P139625

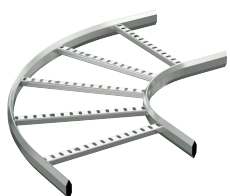

Beskrivelse	Dimensioner i mm A/B/C		Vare-nr.	EAN-kode
Kabelstige KHZPS				
Kabelstige KHZPS 150	55/147/6000		725 350	
Kabelstige KHZPS 200	55/197/6000		725 351	
Kabelstige KHZPS 300	55/297/6000		725 352	
Kabelstige KHZPS 400	55/397/6000		725 353	
Kabelstige KHZPS 500	55/497/6000		725 354	
Kabelstige KHZPS 600	55/597/6000		725 355	



P140034





















Indvendig 90° bøjning 15				
Indvendig 90° bøjning 15/150 varmgalvaniseret	55/547/547		716 066	
Indvendig 90° bøjning 15/200	55/597/597		723 061	
Indvendig 90° bøjning 15/300	55/697/697		723 062	
Indvendig 90° bøjning 15/400	55/797/797		723 063	
Indvendig 90° bøjning 15/500	55/897/897		723 064	
Indvendig 90° bøjning 15/600	55/997/997		723 065	

P140035



Udvendig 90° bøjning 15, varmgalvaniseret				
Udvendig bøjning 90° 15/150	55/703/703		716 179	
Udvendig bøjning 90° 15/200	55/933/933		716 180	
Udvendig bøjning 90° 15/300	55/1133/1133		716 182	
Udvendig bøjning 90° 15/400	55/1333/1333		716 183	
Udvendig bøjning 90° 15/500	55/1533/1533		716 184	
Udvendig bøjning 90° 15/600	55/1733/1733		716 185	

Kabelstige KHZPS

	Beskrivelse	Dimensioner i mm	 Vare-nr.	EAN-kode
P140034	T-afgrening, varmgalvaniseret			
	T-afgrening 16/150	55/944/547	716 193	
	T-afgrening 16/200	55/997/597	716 194	
	T-afgrening 16/300	55/1097/697	716 196	
	T-afgrening 16/400	55/1197/797	716 197	
	T-afgrening 16/500	55/1297/897	716 198	
	T-afgrening 16/600	55/1397/997	716 199	
P140039	X-afgrening, varmgalvaniseret			
	X-afgrening 17/150	55/547/547	716 209	
	X-afgrening 17/200	55/997/997	716 210	
	X-afgrening 17/300	55/997/997	716 212	
	X-afgrening 17/400	55/997/997	716 213	
	X-afgrening 17/500	55/997/997	716 214	
	X-afgrening 17/600	55/997/997	716 215	
P140032	Vertikalafgrening, varmgalvaniseret			
	Vertikalafgrening 18/150	452/147/452	718 176	
	Vertikalafgrening 18/200	452/197/452	718 177	
	Vertikalafgrening 18/300	452/297/452	718 179	
	Vertikalafgrening 18/400	452/397/452	718 180	
	Vertikalafgrening 18/500	452/497/452	718 181	
	Vertikalafgrening 18/600	452/597/452	718 182	

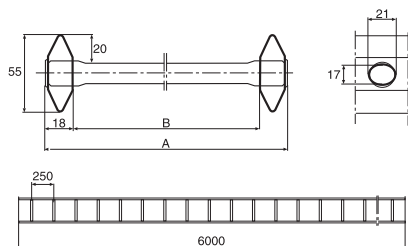

Kabelstige KHZ til store belastninger

Materiale: Varmgalvaniseret stål, FZV
Korrosionsklasse; C4
Længde: 6 meter

Kabelstige KHZ

P139633



Beskrivelse	Dimensioner i mm A/B/C	Vare-nr.	EAN-kode
Kabelstige KHZ			
Kabelstige KHZ 150	55/147/6000	768 001	7 321677 680016
Kabelstige KHZ 200	55/197/6000	768 002	7 321677 680023
Kabelstige KHZ 300	55/297/6000	768 004	7 321677 680047
Kabelstige KHZ 400	55/397/6000	768 005	7 321677 680054
Kabelstige KHZ 500	55/497/6000	768 006	7 321677 680061
Kabelstige KHZ 600	55/597/6000	768 007	7 321677 680078

P140034

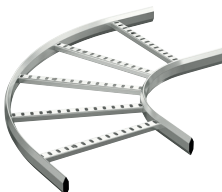



















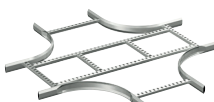



Indvendig 90° bøjning 15			
Indvendig 90° bøjning 15/150	55/547/547	716 066	7 321677 160662
Indvendig 90° bøjning 15/200	55/597/597	716 067	7 321677 160679
Indvendig 90° bøjning 15/300	55/697/697	716 069	7 321677 160693
Indvendig 90° bøjning 15/400	55/797/797	716 070	7 321677 160709
Indvendig 90° bøjning 15/500	55/897/897	716 071	7 321677 160716
Indvendig 90° bøjning 15/600	55/997/997	716 072	7 321677 160723

P140035



Udvendig 90° bøjning 15,			
Udvendig bøjning 90° 15/150	55/703/703	716 179	7 321677 161799
Udvendig bøjning 90° 15/200	55/933/933	716 180	7 321677 161805
Udvendig bøjning 90° 15/300	55/1133/1133	716 182	7 321677 161829
Udvendig bøjning 90° 15/400	55/1333/1333	716 183	7 321677 161836
Udvendig bøjning 90° 15/500	55/1533/1533	716 184	7 321677 161843
Udvendig bøjning 90° 15/600	55/1733/1733	716 185	7 321677 161850

Kabelstige KHZ

	Beskrivelse	Dimensioner i mm	 Vare-nr.	EAN-kode
P140034		T-afgrening		
	T-afgrening 16/150	55/944/547	716 193	
	T-afgrening 16/200	55/997/597	716 194	
	T-afgrening 16/300	55/1097/697	716 196	
	T-afgrening 16/400	55/1197/797	716 197	
	T-afgrening 16/500	55/1297/897	716 198	
	T-afgrening 16/600	55/1397/997	716 199	
P140039		X-afgrening		
	X-afgrening 17/150	55/547/547	716 209	
	X-afgrening 17/200	55/997/997	716 210	
	X-afgrening 17/300	55/997/997	716 212	
	X-afgrening 17/400	55/997/997	716 213	
	X-afgrening 17/500	55/997/997	716 214	
	X-afgrening 17/600	55/997/997	716 215	
P140032		Vertikalafgrening		
	Vertikalafgrening 18/150	452/147/452	718 176	
	Vertikalafgrening 18/200	452/197/452	718 177	
	Vertikalafgrening 18/300	452/297/452	718 179	
	Vertikalafgrening 18/400	452/397/452	718 180	
	Vertikalafgrening 18/500	452/497/452	718 181	
	Vertikalafgrening 18/600	452/597/452	718 182	

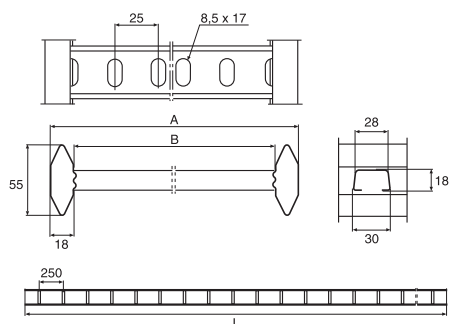

Kabelstige KHZP til store belastninger

Materiale: Varmgalvaniseret stål, FZV
Korrosionsklasse; C4
Længde: 6 meter

Kabelstige KHZP

P139625



Beskrivelse	Dimensioner i mm A/B/C	Vare-nr.	EAN-kode
Kabelstige KHZP			
Kabelstige KHZP 150	55/147/6000	718 562	7 321677 185627
Kabelstige KHZP 200	55/197/6000	718 563	7 321677 185634
Kabelstige KHZP 300	55/297/6000	718 564	7 321677 185641
Kabelstige KHZP 400	55/397/6000	718 565	7 321677 185658
Kabelstige KHZP 500	55/497/6000	718 566	7 321677 185665
Kabelstige KHZP 600	55/597/6000	718 567	7 321677 185672

P140034

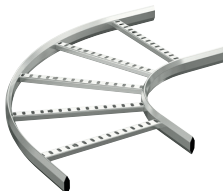



















Indvendig 90° bøjning 15			
Indvendig 90° bøjning 15/200	547 x 268	716 066	7 321677 160662
Indvendig 90° bøjning 15/200	597x 268	716 067	7 321677 160679
Indvendig 90° bøjning 15/300	697x 268	716 069	7 321677 160693
Indvendig 90° bøjning 15/400	797x 268	716 070	7 321677 160709
Indvendig 90° bøjning 15/500	897x 268	716 071	7 321677 160716
Indvendig 90° bøjning 15/600	997x 268	716 072	7 321677 160723







P140035



Udvendig 90° bøjning 15,			
Udvendig bøjning 90° 15/150	55/703/703	716 179	7 321677 161799
Udvendig bøjning 90° 15/200	55/933/933	716 180	7 321677 161805
Udvendig bøjning 90° 15/300	55/1133/1133	716 182	7 321677 161829
Udvendig bøjning 90° 15/400	55/1333/1333	716 183	7 321677 161836
Udvendig bøjning 90° 15/500	55/1533/1533	716 184	7 321677 161843
Udvendig bøjning 90° 15/600	55/1733/1733	716 185	7 321677 161850

Kabelstige KHZP









	Beskrivelse	Dimensioner i mm	 Vare-nr.	EAN-kode
P140034	T-afgrening			
	T-afgrening 16/150	55/944/547	716 193	
	T-afgrening 16/200	55/997/597	716 194	
	T-afgrening 16/300	55/1097/697	716 196	
	T-afgrening 16/400	55/1197/797	716 197	
	T-afgrening 16/500	55/1297/897	716 198	
	T-afgrening 16/600	55/1397/997	716 199	
P140039	X-afgrening			
	X-afgrening 17/150	55/547/547	716 209	
	X-afgrening 17/200	55/997/997	716 210	
	X-afgrening 17/300	55/997/997	716 212	
	X-afgrening 17/400	55/997/997	716 213	
	X-afgrening 17/500	55/997/997	716 214	
	X-afgrening 17/600	55/997/997	716 215	
P140032	Vertikalafgrening			
	Vertikalafgrening 18/150	452/147/452	718 176	
	Vertikalafgrening 18/200	452/197/452	718 177	
	Vertikalafgrening 18/300	452/297/452	718 179	
	Vertikalafgrening 18/400	452/397/452	718 180	
	Vertikalafgrening 18/500	452/497/452	718 181	
	Vertikalafgrening 18/600	452/597/452	718 182	

Konsoller						
	Beskrivelse	Dimensioner i mm		Vare-nr.	EAN-kode	
P138932	Konsol 50i, sendzimirgalvaniseret					
	 Konsol 50i/200	85/250/40		791 413		7 321677 914135
	Konsol 50i/300	110/350/43		791 414		7 321677 914142
	Konsol 50i/400	115/450/44		791 415		7 321677 914159
P140016	Konsol 50L, varmgalvaniseret					
	 Konsol 50L/150	85/200/40		725 106		7 321677 251063
	Konsol 50L/200	85/250/40		725 107		7 321677 251070
	Konsol 50L/300	105/348/40		725 109		7 321677 251094
	Konsol 50L/400	120/447/50		725 110		7 321677 251100
	Konsol 50L/500	140/548/50		725 111		7 321677 251117
	Konsol 50L/600	150/646/50		725 112		7 321677 251124
P140019	Konsol 50, varmgalvaniseret					
	 Konsol 50/150	85/200/40		723 433		7 321677 234332
	Konsol 50/200	85/250/40		723 434		7 321677 234349
	Konsol 50/250	105/300/40		723 435		7 321677 234356
	Konsol 50/300	105/350/40		723 436		7 321677 234363
	Konsol 50/400	120/450/50		723 437		7 321677 234370
	Konsol 50/500	140/550/50		723 438		7 321677 234387
	Konsol 50/600	150/650/50		723 439		7 321677 234394
P138923	Konsolklemme 42					
	 Konsolklemme 42, sendzimirgalvaniseret	54/57/30		721 121		7 321677 211210
	Konsolklemme 42, varmgalvaniseret	54/57/30		705 611		7 321677 056118
P138929	Bæring 3, varmgalvaniseret					
	 Bæring 3/150	92/57/150		720 761		7 321677 207619
	Bæring 3/200	92/57/200		720 762		7 321677 207626
	Bæring 3/300	92/57/300		720 763		7 321677 207633
	Bæring 3/400	92/57/400		720 764		7 321677 207640
	Bæring 3/500	92/57/500		720 765		7 321677 207657
	Bæring 3/600	92/57/600		720 766		7 321677 207664

Konsoller



P139538



Beskrivelse	Dimensioner i mm	 Vare-nr.	EAN-kode
Loftpendel 2F, varmgalvaniseret			
Loftpendel 2F/280	280/80/135	717 196	
Loftpendel 2F/370	370/80/135	717 197	
Loftpendel 2F/505	505/80/135	717 198	
Loftpendel 2F/640	640/80/135	CSU794202	
Loftpendel 2F/730	730/80/135	717 199	
Loftpendel 2F/865	865/80/135	CSU794203	
Loftpendel 2F/1000	1000/80/135	717 200	
Loftpendel 2F/1500	1500/80/135	787 276	

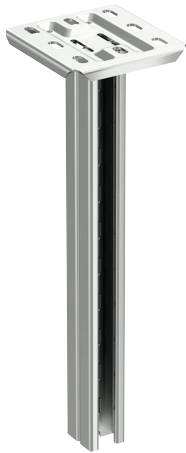

P139842



Loftpendel 20, varmgalvaniseret			
Loftpendel 20/280	280/155/150	CSU794204	
Loftpendel 20/370	370/155/150	CSU794205	
Loftpendel 20/505	505/155/150	715 723	
Loftpendel 20/640	640/155/150	CSU794206	
Loftpendel 20/730	730/155/150	715 724	
Loftpendel 20/865	865/155/150	CSU794207	
Loftpendel 20/1000	1000/155/150	715 725	
Loftpendel 20/1500	1495/155/150	715 726	
Loftpendel 20/2000	1990/155/150	715 727	
Loftpendel 20/3000	2980/155/150	715 728	

P140401, P139654



Samling 21, zink+			
Samling 21, inkl. skrue	64/22/300	CSU795051	
Samling 21, skrueløs	64/32/200	CSU795050	

P139657













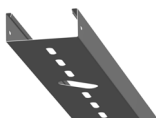

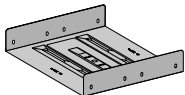

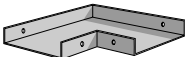

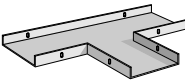

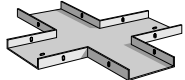





Vinkelkrog 4, aluminium			
Vinkelkrog 4	71/19/86	709 017	

P139864

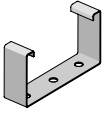

Endefæste 10, aluminium			
Endefæste 10	60/55/60	709 018	

Konsoller					
		Beskrivelse	Dimensioner i mm	Vare-nr.	EAN-kode
P139933		Vægfæste 11/25 og 11/75 (inkl. skrue MVBF 8x40 + møtrik)			
		Vægfæste 11/25 sendzimirgalvaniseret	85/71/40	721 105	7 321677 211050
		Vægfæste 11/75 sendzimirgalvaniseret	135/71/40	721 106	7 321677 211067
		Vægfæste 11/25 varmgalvaniseret	85/71/40	713 204	7 321677 132041
		Vægfæste 11/75 varmgalvaniseret	135/71/40	713 203	7 321677 132034
P140031		Dåseplade 35P			
		Dåseplade 35P sendzimirgalvaniseret	-/106/250	718 618	7 321677 186181
		Dåseplade 35P varmgalvaniseret	-/106/250	731 745	7 321677 317455
P132524		Dåseplade 35S, sendzimirgalvaniseret			
		Dåseplade 35S sendzimirgalvaniseret	164/20/179	711 205	7 321677 120505
P140041		Telerende 36, sendzimirgalvaniseret			
		Telerende 36/50	24/50/2000	725 065	7 321677 250653
		Telerende 36/100	24/100/2000	725 066	7 321677 250660
		Telerende 36/200	24/200/2000	725 067	7 321677 250677
P140041		Telerende 36, varmgalvaniseret			
		Telerende 36/50	24/50/2000	731 748	7 321677 317486
		Telerende 36/100	24/100/2000	731 749	7 321677 317493
		Telerende 36/200	24/200/2000	731 750	7 321677 317509
P140151		Skruesæt 22S, varmgalvaniseret			
		Skruesæt 22S (skrue MVBF 8x16 + møtrik M6MF8)	M8x16	713 694	7 321677 136940
P140152		Møtrik 24S, varmgalvaniseret			
		Fjedermøtrik 24S	-	716 407	7 321677 164073
		Skrue M8x25	M8x25	619 645	7 321676 196457
P140072		T-bolt 26F, varmgalvaniseret			
		T-bolt 26F M10	M10x30	716 794	7 321677 167944
		T-bolt 26F M10	M10x40	715 795	7 321677 167951

Armaturskinner, sendzimirgalvaniseret					
	Beskrivelse	Dimensioner i mm	Vare-nr.	EAN-kode	
P135002		Armaturskinne W70-70	40/70/3000	CSU794123	
B224147		Bæring W7 Bæring W7/40-70	38/68/200	720 825	
B223812		Hjørne W10 Hjørne W10/40-70 90°	38/167/167	717 903	
B223833		T-afgrening W12 T-afgrening W12/40-70	32/267/267	717 908	
B223836		X-afgrening W13 X-afgrening W13 /40-70	38/267/267	717 913	
B223988		Skruesæt W38P Skruesæt W38P	M6	735 177	
B223722		Ophæng W20 Ophæng W20-70	38/75/66	720 973	
B223724		Ophæng W20A Ophæng W20A-70	145/75/66	720 970	
B223888		Gevindstang W76 Gevindstang W76	2000/10/10	716 792	
B223896		Møtrik Møtrik M10	M10	723 938	
B224855		Armaturophæng W25 Armaturophæng W25/40-70	62/30/72	713 911	
B223988		Skruesæt W36 Skruesæt W36	M8	715 646	

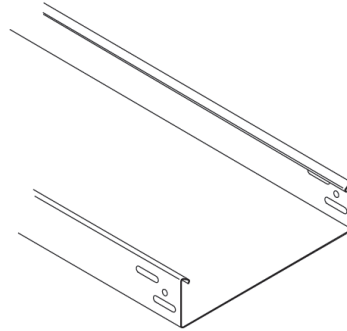

Kabelbakke KB184 glat med kraftig ombukket kant

Materiale: Senzimirgalvaniseret stål, FZS

Korrosionsklasse; C2

Længde: 3 meter

Kabelbakke KB184

8601204

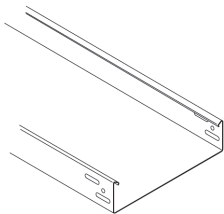

Beskrivelse	Dimensioner i mm	Vare-nr.	EAN-kode
Kabelbakke KB184			
Kabelbakke KG 281/70	60/70/3000	CSU0860 1204	8 712186 037641
Kabelbakke KB 184/100	60/100/3000	CSU7600 1004	8 712186 041631
Kabelbakke KB 184/150	60/150/3000	CSU7600 1504	8 712186 041655
Kabelbakke KB 184/200	60/200/3000	CSU7600 2004	8 712186 041679
Kabelbakke KB 184/300	60/300/3000	CSU7600 3004	8 712186 041686
Kabelbakke KB 184/400	60/400/3000	CSU7600 4004	8 712186 041693
Kabelbakke KB 184/500	60/500/3000	CSU7600 5004	8 712186 041716
Kabelbakke KB 184/600	60/600/3000	CSU7600 6004	8 712186 041730

P133566

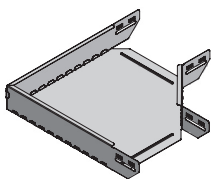

Hjørne 90°, sendzimirgalvaniseret. Fastgøres med samlestykke			
Hjørne 90°/70	60/70/70	CSU3606 0702	8 712186 063992
Hjørne 90°/100	60/100/100	CSU3606 1002	8 712186 064005
Hjørne 90°/150	60/150/150	CSU3606 1502	8 712186 064029
Hjørne 90°/200	60/200/200	CSU3606 2002	8 712186 064036
Hjørne 90°/300	60/300/300	CSU3606 3002	8 712186 064050
Hjørne 90°/400	60/400/400	CSU3606 4002	8 712186 064074
Hjørne 90°/500	60/500/500	CSU3606 5002	8 712186 064081
Hjørne 90°/600	60/600/600	CSU3606 6002	8 712186 064098

Kabelbakke KB184

P133570

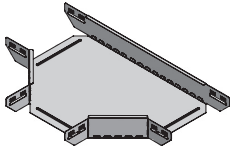

Beskrivelse	Dimensioner i mm	Vare-nr.	EAN-kode
T-stykke, sendzimirgalvaniseret. Fastgøres med samlestykke.			
T-stykke/70	60/70/70	CSU3615 0702	8 712186 064562
T-stykke/100	60/100/100	CSU3615 1002	8 712186 064579
T-stykke/150	60/150/150	CSU3615 1502	8 712186 064593
T-stykke/200	60/200/200	CSU3615 2002	8 712186 064609
T-stykke/300	60/300/300	CSU3615 3002	8 712186 064623
T-stykke/400	60/400/400	CSU3615 4002	8 712186 064647
T-stykke/500	60/500/500	CSU3615 5002	8 712186 064654
T-stykke/600	60/600/600	CSU3615 6002	8 712186 064661

P133572

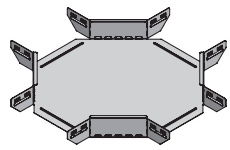

X-stykke, sendzimirgalvaniseret. Fastgøres med samlestykke.			
X-stykke/70	60/70/70	CSU3616 0702	8 712186 064784
X-stykke/100	60/100/100	CSU3616 1002	8 712186 064791
X-stykke/150	60/150/150	CSU3616 1502	8 712186 064814
X-stykke/200	60/200/200	CSU3616 2002	8 712186 064821
X-stykke/300	60/300/300	CSU3616 3002	8 712186 064845
X-stykke/400	60/400/400	CSU3616 4002	8 712186 064869
X-stykke/500	60/500/500	CSU3616 5002	8 712186 064876
X-stykke/600	60/600/600	CSU3616 6002	8 712186 064883

P133568

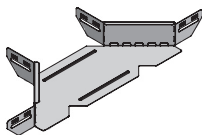

T-afgrening, sendzimirgalvaniseret. Fastgøres med samlestykke.			
T-afgrening/70	60/70/70	CSU3607 0702	8 712186 064210
T-afgrening/100	60/100/100	CSU3607 1002	8 712186 064227
T-afgrening/150	60/150/150	CSU3607 1502	8 712186 064241
T-afgrening/200	60/200/200	CSU3607 2002	8 712186 064258
T-afgrening/300	60/300/300	CSU3607 3002	8 712186 064272
T-afgrening/400	60/400/400	CSU3607 4002	8 712186 064296
T-afgrening/500	60/500/500	CSU3607 5002	8 712186 064302
T-afgrening/600	60/600/600	CSU3607 6002	8 712186 064319

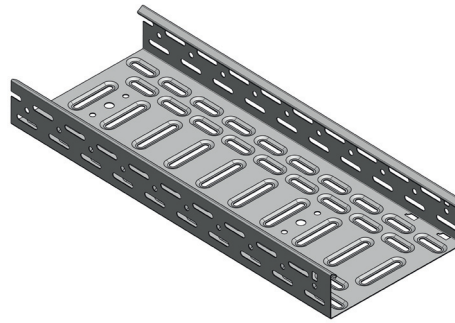



Kabelbakke KB284 perforeret med kraftig ombukket kant

Materiale: Senzimirgalvaniseret stål, FZS
 Korrosionsklasse; C2
 Længde: 3 meter

Kabelbakke KB284

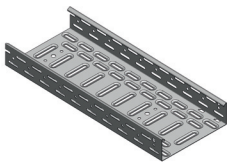
P1337709



Beskrivelse	Dimensioner i mm	 Vare-nr.	EAN-kode
Kabelbakke KB284			
Kabelbakke KB 284/100	60/100/3000	CSU2601 1002	8 712186 040153
Kabelbakke KB 284/150	60/150/3000	CSU2601 1502	8 712186 040177
Kabelbakke KB 284/200	60/200/3000	CSU2601 2002	8 712186 040191
Kabelbakke KB 284/300	60/300/3000	CSU2601 3002	8 712186 040238
Kabelbakke KB 284/400	60/400/3000	CSU2601 4002	8 712186 040252
Kabelbakke KB 284/500	60/500/3000	CSU2601 5004	8 712186 040283
Kabelbakke KB 284/600	60/600/3000	CSU2601 6004	8 712186 040306

P133566

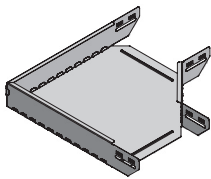

Hjørne 90°, sendzimirgalvaniseret. Fastgøres med samlestykke			
Hjørne 90°/100	60/100/100	CSU3606 1002	8 712186 064005
Hjørne 90°/150	60/150/150	CSU3606 1502	8 712186 064029
Hjørne 90°/200	60/200/200	CSU3606 2002	8 712186 064036
Hjørne 90°/300	60/300/300	CSU3606 3002	8 712186 064050
Hjørne 90°/400	60/400/400	CSU3606 4002	8 712186 064074
Hjørne 90°/500	60/500/500	CSU3606 5002	8 712186 064081
Hjørne 90°/600	60/600/600	CSU3606 6002	8 712186 064098

Kabelbakke KB284

P1133570

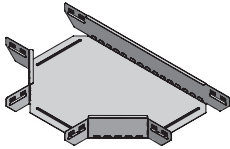

Beskrivelse	Dimensioner i mm	Vare-nr.	EAN-kode
T-stykke, sendzimirgalvaniseret. Fastgøres med samlestyrke.			
T-stykke/100	60/100/100	CSU3615 1002	8 712186 064579
T-stykke/150	60/150/150	CSU3615 1502	8 712186 064593
T-stykke/200	60/200/200	CSU3615 2002	8 712186 064609
T-stykke/300	60/300/300	CSU3615 3002	8 712186 064623
T-stykke/400	60/400/400	CSU3615 4002	8 712186 064647
T-stykke/500	60/500/500	CSU3615 5002	8 712186 064654
T-stykke/600	60/600/600	CSU3615 6002	8 712186 064661

P1133572

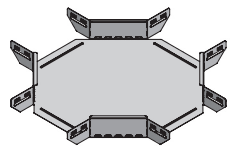

X-stykke, sendzimirgalvaniseret. Fastgøres med samlestyrke.			
X-stykke/100	60/100/100	CSU3616 1002	8 712186 064791
X-stykke/150	60/150/150	CSU3616 1502	8 712186 064814
X-stykke/200	60/200/200	CSU3616 2002	8 712186 064821
X-stykke/300	60/300/300	CSU3616 3002	8 712186 064845
X-stykke/400	60/400/400	CSU3616 4002	8 712186 064869
X-stykke/500	60/500/500	CSU3616 5002	8 712186 064876
X-stykke/600	60/600/600	CSU3616 6002	8 712186 064883

P1133588

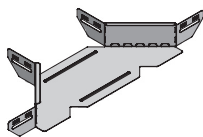

T-afgrening, sendzimirgalvaniseret. Fastgøres med samlestyrke.			
T-afgrening/100	60/100/100	CSU3607 1002	8 712186 064227
T-afgrening/150	60/150/150	CSU3607 1502	8 712186 064241
T-afgrening/200	60/200/200	CSU3607 2002	8 712186 064258
T-afgrening/300	60/300/300	CSU3607 3002	8 712186 064272
T-afgrening/400	60/400/400	CSU3607 4002	8 712186 064296
T-afgrening/500	60/500/500	CSU3607 5002	8 712186 064302
T-afgrening/600	60/600/600	CSU3607 6002	8 712186 064319

Konsoller

P138932



Beskrivelse	Dimensioner i mm	 Vare-nr.	EAN-kode
Konsol 50i, sendzimirgalvaniseret			
Konsol 50i/100	85/150/40	791 412	
Konsol 50i/200	85/250/40	791 413	
Konsol 50i/300	110/350/43	791 414	
Konsol 50i/400	115/450/44	791 415	

P140016



Konsol 50L, varmgalvaniseret			
Konsol 50L/100	85/150/40	725 105	
Konsol 50L/150	85/200/40	725 106	
Konsol 50L/200	85/250/40	725 107	
Konsol 50L/300	105/348/40	725 109	
Konsol 50L/400	120/447/50	725 110	
Konsol 50L/500	140/548/50	725 111	
Konsol 50L/600	150/646/50	725 112	

P133476

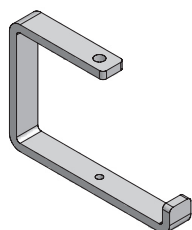

Ophæng type åben, 900. Varmgalvaniseret			
Ophæng type åben, 900/70	45/70/5	CSU0817 1200	
Ophæng type åben, 900/100	45/100/10	CSU0817 3100	
Ophæng type åben, 900/150	45/150/10	CSU0817 1500	
Ophæng type åben, 900/200	45/200/10	CSU0817 3200	
Ophæng type åben, 900/250	45/250/10	CSU0817 4200	
Ophæng type åben, 900/300	45/300/10	CSU0817 3300	

P138938



Loftpendel 2F, varmgalvaniseret			
Loftpendel 2F/280	280/80/135	717 196	
Loftpendel 2F/370	370/80/135	717 197	
Loftpendel 2F/505	505/80/135	717 198	
Loftpendel 2F/640	640/80/135	CSU794202	
Loftpendel 2F/730	730/80/135	717 199	
Loftpendel 2F/865	865/80/135	CSU794203	
Loftpendel 2F/1000	1000/80/135	717 200	
Loftpendel 2F/1500	1500/80/135	787 276	

Konsoller

P139942

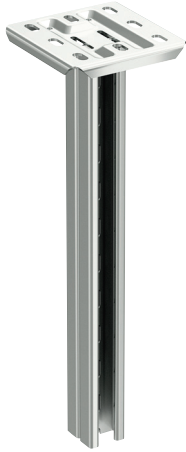

Beskrivelse	Dimensioner i mm	Vare-nr.	EAN-kode
Loftpendel 20, varmgalvaniseret			
Loftpendel 20/280	280/155/150	CSU794204	3 606480 409967
Loftpendel 20/370	370/155/150	CSU794205	3 606480 409974
Loftpendel 20/505	505/155/150	715 723	7 321677 157235
Loftpendel 20/640	640/155/150	CSU794206	3 606480 409981
Loftpendel 20/730	730/155/150	715 724	7 321677 157242
Loftpendel 20/865	865/155/150	CSU794207	3 606480 409998
Loftpendel 20/1000	1000/155/150	715 725	7 321677 157259
Loftpendel 20/1500	1495/155/150	715 726	7 321677 157266
Loftpendel 20/2000	1990/155/150	715 727	7 321677 157273
Loftpendel 20/3000	2980/155/150	715 728	7 321677 157280

3504

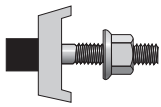

T-bolt 26F, varmgalvaniseret			
T-bolt 26F M8	24/30	734 744	7 321677 347445
T-bolt 26F M10	24/30	716 794	7 321677 167944
T-bolt 26F M8	34/40	734 745	7 321677 347452
T-bolt 26F M10	34/40	716 795	7 321677 167951

P133448

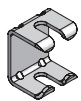

Loftophæng (2500N), varmgalvaniseret			
Loftophæng	50/40/35	CSU0802 0200	8 712186 001345

P133444



Loftophæng (1500N), varmgalvaniseret			
Loftophæng, universal	50/40/40	CSU0802 0100	8 712186 001321

P133477



Møtrik			
Møtrik	M10	CSU0889 0120	8 712186 045943

P133494













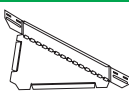





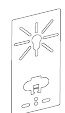





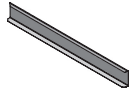

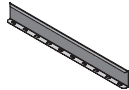

Flangemøtrik, el-forzinket			
Flangemøtrik	M10	CSU0889 0100	8 712186 029158

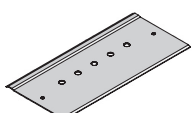
716792



Gevindstang, el-forzinket			
Gevindstang M10	1000/10	734 737	7 321677 347377

Konsoller

	Beskrivelse	Dimensioner i mm	 Vare-nr.	EAN-kode
3811	 Universal hjørne, sendzimirgalvaniseret			
	Universal hjørne	60/60/100	CSU3611 0002	 8 712186 064548
Koppelplad 08.01.80.00	 Koblingsbeslag, sendzimirgalvaniseret			
	Koblingsbeslag, unilock	60/260	CSU0801 0109	 8 712186 117343
	Koblingsbeslag	60/60/100	CSU0801 6000	 8 712186 001291
P 133600	 Justerbart koblingsbeslag, sendzimirgalvaniseret			
	Justerbart koblingsbeslag	60/135	CSU7612 0009	 8 712186 014222
0825 P 133462	 Dåseplade			
	Dåseplade A	245/118,5	CSU0825 0109	 8 712186 002731
	Dåseplade B	140/200	CSU0809 0109	 8 712186 001840
P 133527	 Monteringsclips, rustfri stål			
	Monteringsclips	27,5/16/12	CSU0885 4000	 8 712186 073793
P 133531	 Samlestykke til formstykke, rustfri stål			
	Samlestykke til formstykke	60/38	CSU0885 6050	 8 712186 073816
P 133532	 Deleskinne til holder, sendzimirgalvaniseret			
	Deleskinne til holder	60/25/3000	CSU0887 0100	 8 712186 038044
P 133601	 Deleskinne til skruer, sendzimirgalvaniseret			
	Deleskinne til skruer	55,2/19/3000	CSU7602 0000	 8 712186 041945
P 133533	 Holder til deleskinne, sendzimirgalvaniseret			
	Holder til deleskinne	56/39	CSU0887 0500	 8 712186 006289
P 133534	 Monteringsplade til deleskinne, sendzimirgalvaniseret			
	Monteringsplade til deleskinne/70	50/70	CSU0887 1200	 8 712186 006302
	Monteringsplade til deleskinne/100	50/100	CSU0887 1000	 8 712186 006296
	Monteringsplade til deleskinne/150	50/150	CSU0887 1500	 8 712186 006319
	Monteringsplade til deleskinne/200	50/200	CSU0887 3200	 8 712186 006364
	Monteringsplade til deleskinne/300	50/300	CSU0887 3000	 8 712186 006357
	Monteringsplade til deleskinne/400	50/400	CSU0887 6200	 8 712186 006395
	Monteringsplade til deleskinne/500	50/500	CSU0887 7200	 8 712186 006401
	Monteringsplade til deleskinne/600	50/600	CSU0887 8200	 8 712186 006418

P112508

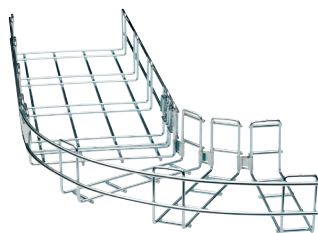

Gitterbakke uden delespor

Materiale: El-galvaniseret stål, FZB og zink+
Korrosionsklasse; C1 og C4
Længde: 3 meter

Gitterbakke

P112508



Beskrivelse	Dimensioner i mm	 Vare-nr.	EAN-kode
Gitterbakke, el-galvaniseret			
Gitterbakke 60x60 EZ	65/60/3000	451 1206	8 428031 034481
Gitterbakke 70x100 EZ	75/100/3000	451 1210	8 428031 034498
Gitterbakke 70x150 EZ	75/150/3000	451 1215	8 428031 034504
Gitterbakke 70x200 EZ	75/200/3000	451 1220	8 428031 034511
Gitterbakke 70x300 EZ	75/300/3000	451 1230	8 428031 034528
Gitterbakke 70x400 EZ	75/400/3000	451 1240	8 428031 034535
Gitterbakke 70x500 EZ	75/500/3000	451 1250	8 428031 034559
Gitterbakke 70x600 EZ	75/600/3000	451 1260	8 428031 034566

P112508



Gitterbakke, zink+			
Gitterbakke 60x60 ZA	65/60/3000	CSU451 8206	3 606480 444944
Gitterbakke 70x100 ZA	75/100/3000	CSU451 8210	3 606480 444951
Gitterbakke 70x150 ZA	75/150/3000	CSU451 8215	3 606480 444968
Gitterbakke 70x200 ZA	75/200/3000	CSU451 8220	3 606480 444975
Gitterbakke 70x300 ZA	75/300/3000	CSU451 8230	3 606480 444982
Gitterbakke 70x400 ZA	75/400/3000	CSU451 8240	3 606480 444999
Gitterbakke 70x500 ZA	75/500/3000	CSU451 8250	3 606480 445002
Gitterbakke 70x600 ZA	75/600/3000	CSU451 8260	3 606480 445019

Gitterbakker

Med delespor



Gitterbakke med delespor







Materiale: El-galvaniseret stål, FZB
 Korrosionsklasse; C1
 Længde: 3 meter









Gitterbakke

P112508



Gitterbakke med delespor, el-galvaniseret

Gitterbakke 1 deleskinne 70/100 (40/60)	75/100/3000	CSU452 1211	 8 428031 160081
Gitterbakke 1 deleskinne 70/200 (60/140)	75/200/3000	CSU452 1221	 8 428031 160098
Gitterbakke 2 deleskinner 70/200 (50/100/50)	75/200/3000	CSU452 1222	 8 428031 160104
Gitterbakke 1 deleskinne 70/300 (100/200)	75/300/3000	CSU452 1231	 8 428031 160111
Gitterbakke 2 deleskinner 70/300 (100/150/50)	75/300/3000	CSU452 1232	 8 428031 160128
Gitterbakke 1 deleskinne 70/400 (100/300)	75/400/3000	CSU452 1241	 8 428031 160135
Gitterbakke 2 deleskinner 70/400 (100/200/100)	75/400/3000	CSU452 1242	 8 428031 160142

Gitterbakke, el-galvaniseret				
	Beskrivelse	Dimensioner i mm	Vare-nr.	EAN-kode
P126436				
	Clips deleskinne, zink+			
	Clips deleskinne 70	57/16/3000	CSU457 8520	8 428031 161002
P112474				
	Samling			
	Samling 70 + 105, el-galvaniseret	10/30/86	453 0200	8 438031 140778
	Samling 70 + 105, zink+	10/30/86	CSU453 8200	3 606480 570940
P112512				
	Samlebolt			
	Samlebolt, el-galvaniseret	27/23/27	456 1110	8 428031 039011
	Samlebolt, zink+	27/23/27	CSU456 8110	8 428031 160463
P112513				
	Samleplade			
	Samleplade 70 + 105, el-galvaniseret	46/80	456 1205	8 428031 039042
	Samleplade 70 + 105, zink+	46/80	CSU456 8205	8 428031 160944
P112518 P112506				
	Universal dåseplade			
	Universal dåseplade + konsol, el-galvaniseret	20/72/92	457 1120	8 428031 039301
	Universal dåseplade + konsol, dobbel, el-galvaniseret	20/100/182	457 1130	8 428031 065980
	Universal dåseplade + konsol, zink+	20/72/92	CSU457 8120	8 428031 160456
	Universal dåseplade + konsol, dobbel, zink+	20/100/182	CSU457 8130	8 428031 160449
P112556				
	Låseclips			
	Låseclips til hjørner, el-galvaniseret	6/18/21	453 0900	8 438031 143960
	Låseclips til hjørner, zink+	6/18/21	453 2900	8 438031 143977
P112553				
	Konsolklemme			
	Konsolklemme, el-galvaniseret	23,5/23,5	456 1120	8 428031 039028
	Konsolklemme, zink+	23,5/23,5	CSU456 8120	8 428031 160647
P112466				
	Kabeldrop			
	Kabeldrop, el-galvaniseret	50/37/111	453 0700	8 438031 141065
	Kabeldrop, zink+	50/40/111	453 2700	8 438031 141072
P112542				
	Labelplade			
	Labelplade	30/100	455 1485	8 428031 073558

Tilbehør til gitterbakke

P112514



Beskrivelse	Dimensioner i mm	Vare-nr.	EAN-kode
Clipskonsol, el-galvaniseret			
Clipskonsol 100	82/42/144	455 0110	8 428031 075965
Clipskonsol 150	82/42/194	455 0111	8 428031 075972
Clipskonsol 200	82/42/244	455 0112	8 428031 075989
Clipskonsol 300	82/42/344	455 0113	8 428031 075996

Clipskonsol, zink+			
Clipskonsol 100	82/42/144	CSU455 8110	8 428031 160487
Clipskonsol 150	82/42/194	CSU455 8111	8 428031 160494
Clipskonsol 200	82/42/244	CSU455 8112	8 428031 160500
Clipskonsol 300	82/42/344	CSU455 8113	8 428031 160517

P112516



Vægkonsol Omega, el-galvaniseret			
Vægkonsol Omega 100	131/50/150	455 0310	8 428031 083762
Vægkonsol Omega 150	131/50/200	455 0315	8 428031 083779
Vægkonsol Omega 200	131/50/250	455 0320	8 428031 083786
Vægkonsol Omega 300	131/50/350	455 0330	8 428031 083793

Vægkonsol Omega, zink+			
Vægkonsol Omega 100	131/50/150	CSU455 8310	8 428031 160821
Vægkonsol Omega 150	131/50/200	CSU455 8315	8 428031 160838
Vægkonsol Omega 200	131/50/250	CSU455 8320	8 428031 160845
Vægkonsol Omega 300	131/50/350	CSU455 8330	8 428031 160852

P112521



Loftkonsol Omega, el-galvaniseret			
Loftkonsol Omega SSO 100	196/50/153	455 0410	8 428031 083809
Loftkonsol Omega SSO 150	196/50/204	455 0415	8 428031 083816
Loftkonsol Omega SSO 200	196/50/252	455 0420	8 428031 083823
Loftkonsol Omega SSO 300	196/50/357	455 0430	8 428031 083830

Loftkonsol Omega, zink+			
Loftkonsol Omega SSO 100	196/50/153	CSU455 8410	8 428031 160401
Loftkonsol Omega SSO 150	196/50/204	CSU455 8415	8 428031 160418
Loftkonsol Omega SSO 200	196/50/252	CSU455 8420	8 428031 160425
Loftkonsol Omega SSO 300	196/50/357	CSU455 8430	8 428031 160432

Konsoller

Beskrivelse	Dimensioner i mm 	Vare-nr.	EAN-kode
Loftpendel 2F, varmgalvaniseret			
Loftpendel 2F/280	280/80/135	717 196	
Loftpendel 2F/370	370/80/135	717 197	
Loftpendel 2F/505	505/80/135	717 198	
Loftpendel 2F/640	640/80/135	CSU794202	
Loftpendel 2F/730	730/80/135	717 199	
Loftpendel 2F/865	865/80/135	CSU794203	
Loftpendel 2F/1000	1000/80/135	717 200	
Loftpendel 2F/1500	1500/80/135	787 276	
Loftpendel 20, varmgalvaniseret			
Loftpendel 20/280	280/155/150	CSU794204	
Loftpendel 20/370	370/155/150	CSU794205	
Loftpendel 20/505	505/155/150	715 723	
Loftpendel 20/640	640/155/150	CSU794206	
Loftpendel 20/730	730/155/150	715 724	
Loftpendel 20/865	865/155/150	CSU794207	
Loftpendel 20/1000	1000/155/150	715 725	
Loftpendel 20/1500	1495/155/150	715 726	
Loftpendel 20/2000	1990/155/150	715 727	
Loftpendel 20/3000	2980/155/150	715 728	
T-bolt 26F, varmgalvaniseret			
T-bolt 26F M8	24/30	734 744	
T-bolt 26F M8	34/40	734 745	
Gevindstang, el-forzinket			
Gevindstang M8	1000/8	725 079	
Centerophæng, el-galvaniseret			
Centerophæng	40/4/60	455 1430	

P139898



P139942



3504

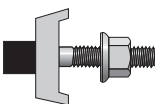

716792



P112523



Schneider Electric Danmark A/S

Industriparken 32
2750 Ballerup
Tlf.: 44 20 70 00
www.schneider-electric.dk
www.lk.dk

Da standarder og produkter er under kontinuerlig udvikling, vil oplysninger i denne brochure ændres løbende. Vi tager forbehold for disse ændringer samt trykfejl og mangler i øvrigt.